

Article number: 46913511

Description: Torque limiter Safeguard A 35 S

## Measures

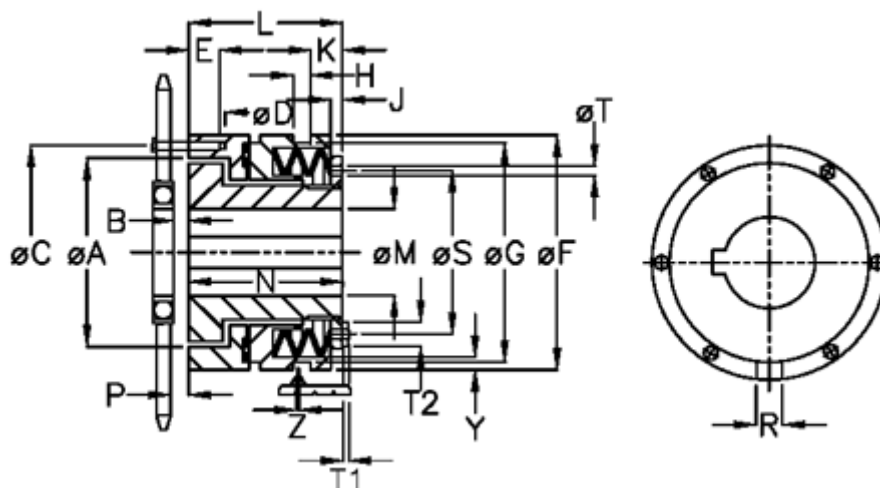

A	= 78.0	G	= 91.0	P	= 4.0
B	= 5.0	H	= 9	R	= 8
C	= 89	J	= 6.0	S	= 70
D	= 6xM6	K	= 12.0	T	= 5
Disc spring mounting	= 6x1S	L	= 61.0	T1	= 4.0
Disc spring version	= S - light	M max	= 35	T2	= 10
E	= 10.0	M min	= 14	Y	= 2
F	= 100	N	= 56.0	Z	= 0.0